

Article number: 6041651320085

Description: Clamping plate for belts HTD 8M 85

Measures

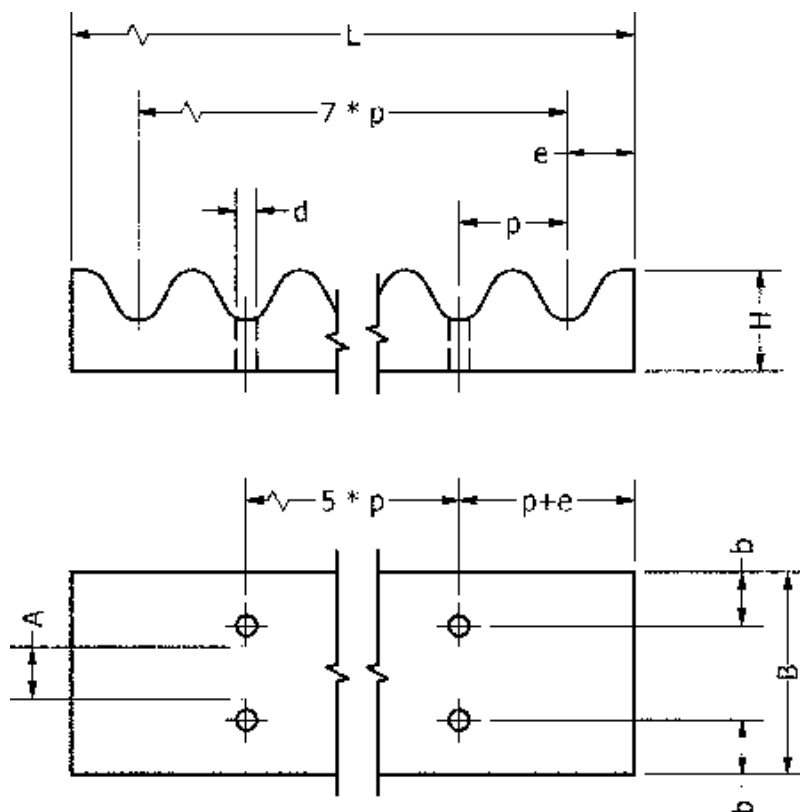

= -	b = 8
= -	B = 110
= -	d = 9
= -	e = 5
= -	H = 15
= -	L = 66
= -	
= -	
A = 85	